

P/V

R.O. (Inches)	R.O. (mm)									
	320	420	520	620	770	920	1020	1220	48	
	O.S.M. (mm)	300	400	500	600	750	900	1000	1200	
30 1/4	770	750	✓	✓	✓	✓	✓	✓	✓	✓
36 1/4	920	900	✓	✓	✓	✓	✓	✓	✓	✓
40 1/8	1020	1000	✓	✓	✓	✓	✓	✓	✓	✓
48	1220	1200	✓	✓	✓	✓	✓	✓	✓	✓
59 7/8	1520	1500	✓	✓	✓	✓	✓	✓	✓	✓
71 5/8	1820	1800	✓	✓	✓	✓	✓	✓	✓	✓
83 1/2	2120	2100	✓	✓	✓	✓	✓	✓	✓	✓

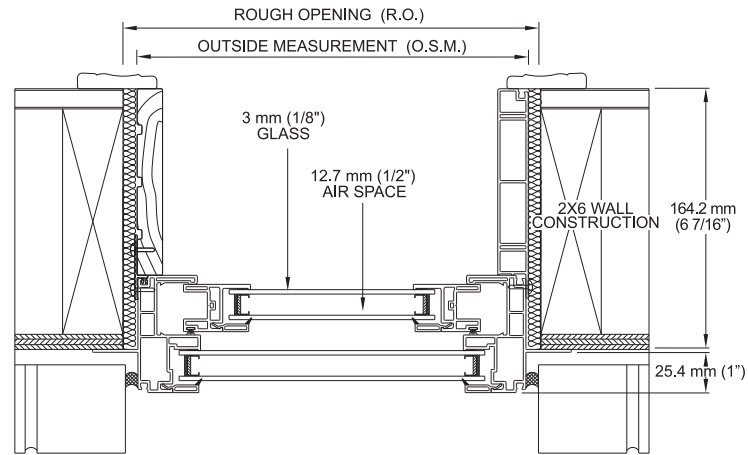

135 SINGLE HUNG HORIZONTAL SECTION

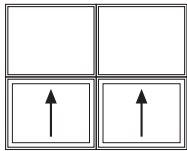

PP/VV

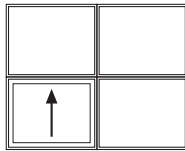

PP/VO

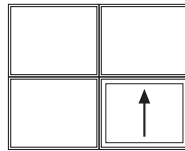

PP/OV

R.O. (Inches)	R.O. (mm)									
	620	770	920	1020	1220	1520	1820	2020	2420	2400
	O.S.M. (mm)	600	750	900	1000	1200	1500	1800	2000	2400
30 1/4	770	750	✓	✓	✓	✓	✓	✓	✓	✓
36 1/4	920	900	✓	✓	✓	✓	✓	✓	✓	✓
40 1/8	1020	1000	✓	✓	✓	✓	✓	✓	✓	✓
48	1220	1200	✓	✓	✓	✓	✓	✓	✓	✓
59 7/8	1520	1500	✓	✓	✓	✓	✓	✓	✓	✓
71 5/8	1820	1800	✓	✓	✓	✓	✓	✓	✓	✓

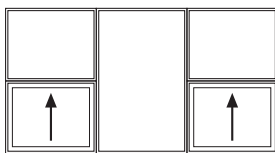

P/V P P/V

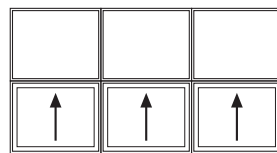

P/V P/V P/V

R.O. (Inches)	R.O. (mm)										
	920	1020	1220	1520	1820	2020	2120	2420	2720	2700	107 1/8
	O.S.M. (mm)	900	1000	1200	1500	1800	2000	2100	2400	2700	
30 1/4	770	750	✓	✓	✓	✓	✓	✓	✓	✓	✓
36 1/4	920	900	✓	✓	✓	✓	✓	✓	✓	✓	✓
40 1/8	1020	1000	✓	✓	✓	✓	✓	✓	✓	✓	✓
48	1220	1200	✓	✓	✓	✓	✓	✓	✓	✓	✓
59 7/8	1520	1500	✓	✓	✓	✓	✓	✓	✓	✓	✓
71 5/8	1820	1800	✓	✓	✓	✓	✓	✓	✓	✓	✓

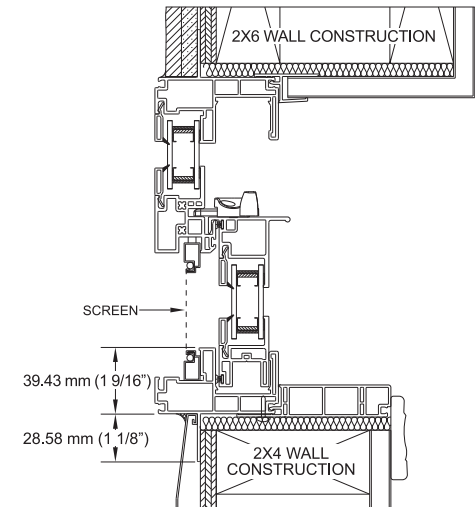

135 SINGLE HUNG VERTICAL SECTION

O.S.M. = Outside measurement
R.O. = Rough opening

Order units as viewed from outside.
Custom sizes available.